

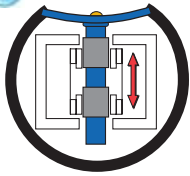

LINEAR



LINEAR DIAPHRAGM LIQUID PUMP LMF SERIES

MODELS

LMF3 115/230 V AC
LMF3 12/24 V AC
LMF4 115/230 V AC
LMF4 12/24 V AC

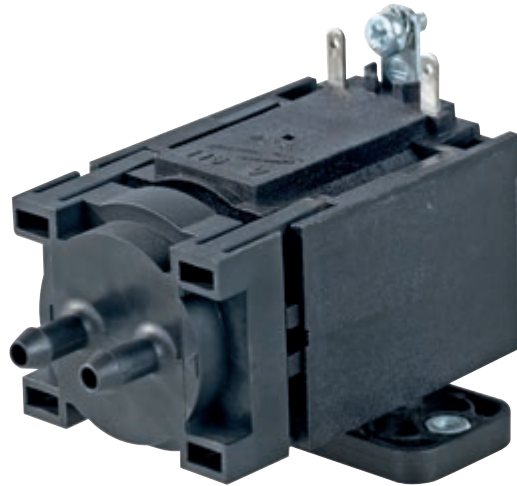

LMF Series

FEATURES

- High Lifetime
- Low Sound
- Self Priming

TYPICAL APPLICATIONS

- Industrial Applications
- Medical Devices
- Laboratory and Analysis
- Dosing Applications
- HVAC
- Fuel Cells



Linear Diaphragm Liquid Pump LMF3 115/230 V AC

Flow	185 ml/min
Pressure height	7 m H₂O
Suction height	2 m H₂O

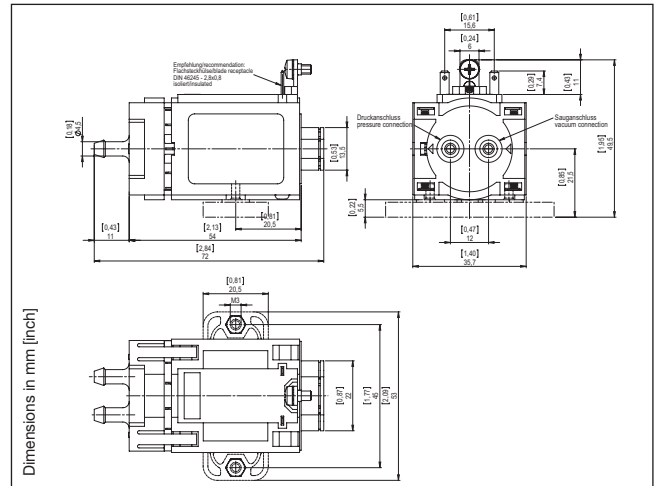
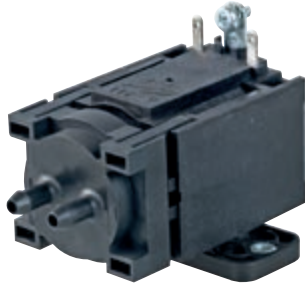

Hydraulic Data

Description	LMF3 115/230 V AC PP/PBT/EPDM	
Part number	115 V/60 Hz	9471410
	230 V/50 Hz	9470410
Max. flow	185 ml/min	
Max. continuous pressure height (flooded)	7 m H ₂ O	
Max. suction height (flooded)	3,5 m H ₂ O	
Max. suction height (dry)	2 m H ₂ O	

Electrical Data

Motor type	Linear magnetic drive
Nominal voltage	115 V 60 Hz / 230 V 50 Hz
Max. power consumption	4,6 W
Protection class	IP00

General Data

Ambient temperature	0 to 50°C
Media temperature	0 to 50°C
Weight	0,14 kg

Wetted Parts

Pump chamber	PP
Nozzle plate	PBT
Diaphragm	EPDM
Valve gasket	EPDM

All listed values are average values and related to a Silicone tubing, OD 6,5 mm x ID 4,5 mm, Hardness Shore D 50. Tolerances depend on viscosity of media, temperature, position of pump/tubing.

Flow Curves

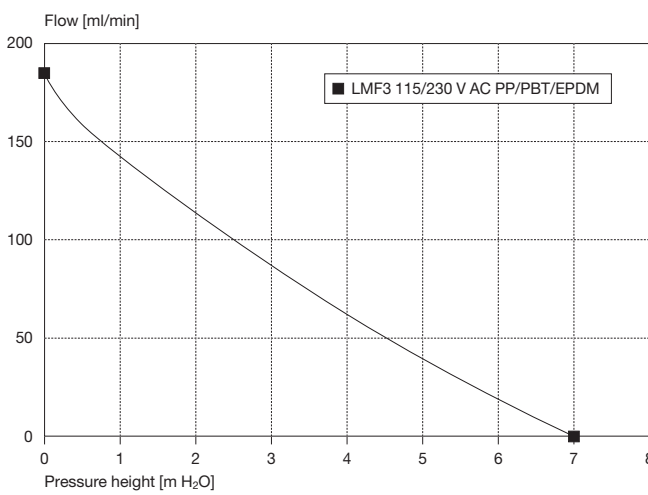

947... Stock programme

The information presented in this material is based on technical data and test results of nominal units. It is believed to be accurate and reliable and is offered as an aid to help in the selection of Thomas products. It is the responsibility of the user to determine the suitability of the product for the intended use and the user assumes all risk and liability whatsoever in connection therewith. Thomas does not warrant, guarantee or assume any obligation or liability in connection with this information.



Linear Diaphragm Liquid Pump LMF3 12/24 V AC

Flow	185 ml/min
Pressure height	7,2 m H₂O
Suction height	2 m H₂O

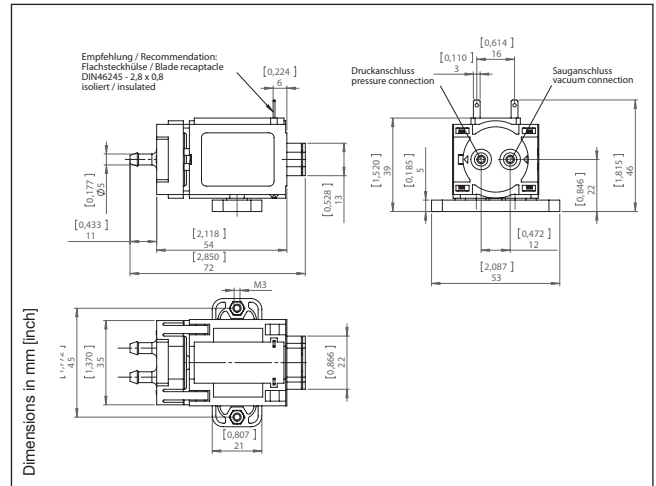
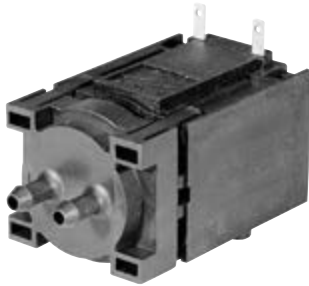

Hydraulic Data

Description	LMF3 12/24 V AC PP/PBT/EPDM	
Part number	12 V/50 Hz	9474310
	24 V/50 Hz	9473310
Max. flow	185 ml/min	
Max. continuous pressure height (flooded)	7,2 m H ₂ O	
Max. suction height (flooded)	3,5 m H ₂ O	
Max. suction height (dry)	2 m H ₂ O	

Electrical Data

Motor type	Linear magnetic drive
Nominal voltage	12 V 50 Hz / 24 V 50 Hz
Max. power consumption	3,8 W
Protection class	IP00

General Data

Ambient temperature	0 to 50°C
Media temperature	0 to 50°C
Weight	0,16 kg

Wetted Parts

Pump chamber	PP
Nozzle plate	PBT
Diaphragm	EPDM
Valve gasket	EPDM

All listed values are average values and related to a Silicone tubing, OD 6,5 mm x ID 4,5 mm, Hardness Shore D 50.
Tolerances depend on viscosity of media, temperature, position of pump/tubing. Dry running during self priming only.
An oscillator for DC supply can be purchased separately under the article number 90520.

Flow Curves

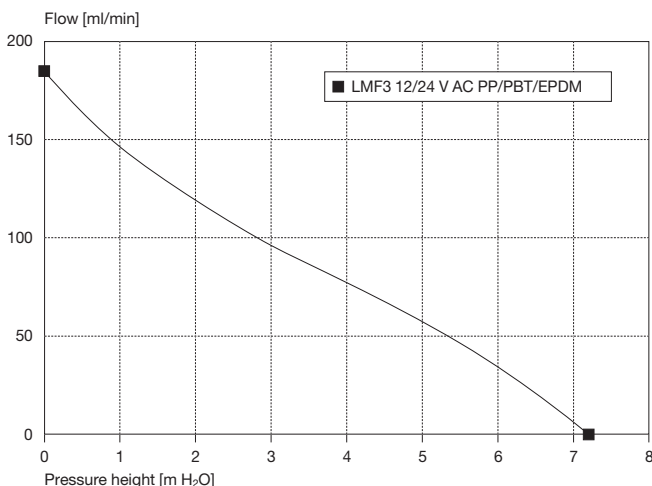

947... Stock programme

The information presented in this material is based on technical data and test results of nominal units. It is believed to be accurate and reliable and is offered as an aid to help in the selection of Thomas products. It is the responsibility of the user to determine the suitability of the product for the intended use and the user assumes all risk and liability whatsoever in connection therewith. Thomas does not warrant, guarantee or assume any obligation or liability in connection with this information.

THOMAS
A Gardner Denver Product

Linear Diaphragm Liquid Pump LMF4 115/230 V AC

Flow	300 ml/min
Pressure height	8 m H₂O
Suction height	3 m H₂O

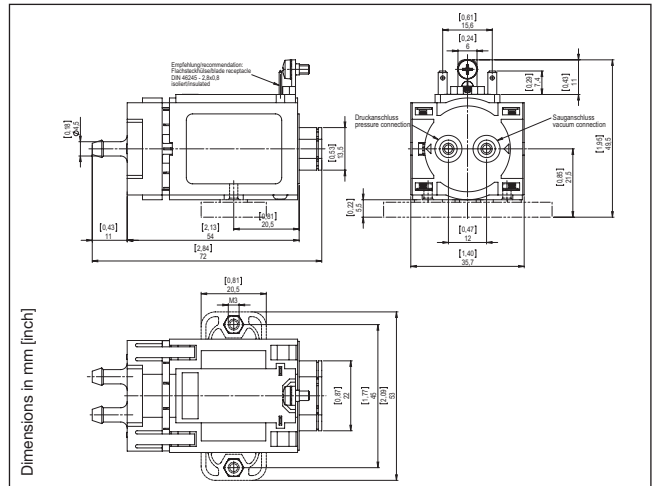
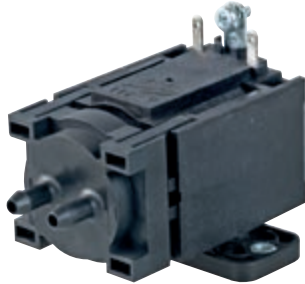

Hydraulic Data

Description	LMF4 115/230 V AC PP/PBT/EPDM	
Part number	115 V/60 Hz	9441410
	230 V/50 Hz	9440410
Max. flow	300 ml/min	
Max. continuous pressure height (flooded)	8 m H ₂ O	
Max. suction height (flooded)	3,5 m H ₂ O	
Max. suction height (dry)	3 m H ₂ O	

Electrical Data

Motor type	Linear magnetic drive
Nominal voltage	115 V 60 Hz / 230 V 50 Hz
Max. power consumption	4,4 W
Protection class	IP00

General Data

Ambient temperature	0 to 50°C
Media temperature	0 to 50°C
Weight	0,165 kg

Wetted Parts

Pump chamber	PP
Nozzle plate	PBT
Diaphragm	EPDM
Valve gasket	EPDM

All listed values are average values and related to a Silicone tubing, OD 6,5 mm x ID 4,5 mm, Hardness Shore D 50. Tolerances depend on viscosity of media, temperature, position of pump/tubing. Dry running during self priming only.

Flow Curves

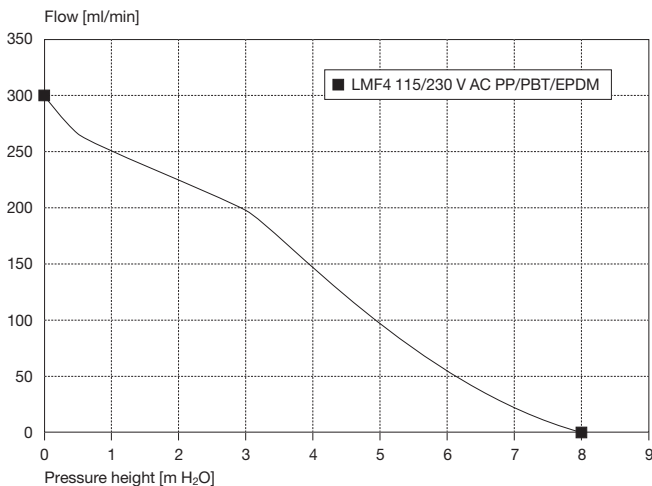

944... Stock programme

The information presented in this material is based on technical data and test results of nominal units. It is believed to be accurate and reliable and is offered as an aid to help in the selection of Thomas products. It is the responsibility of the user to determine the suitability of the product for the intended use and the user assumes all risk and liability whatsoever in connection therewith. Thomas does not warrant, guarantee or assume any obligation or liability in connection with this information.

THOMAS
A Gardner Denver Product

Linear Diaphragm Liquid Pump LMF4 12/24 V AC

Flow	300 ml/min
Pressure height	9 m H₂O
Suction height	3 m H₂O

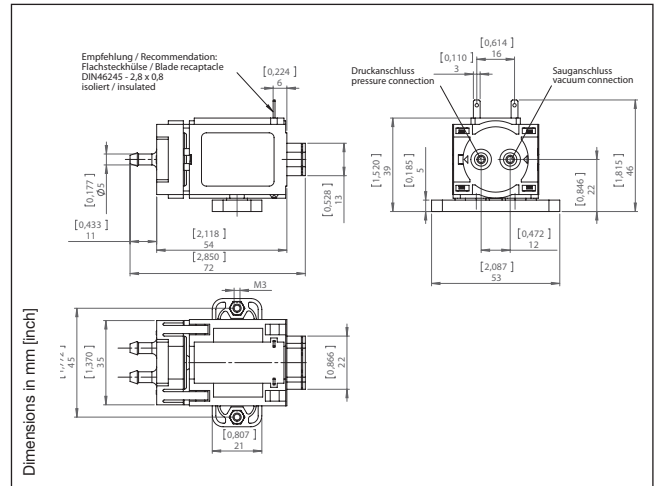
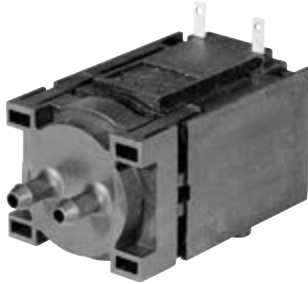

Hydraulic Data

Description	LMF4 12/24 V AC PP/PBT/EPDM	
Part number	12 V/50 Hz	9444310
	24 V/50 Hz	9443310
Max. flow	300 ml/min	
Max. continuous pressure height (flooded)	9 m H ₂ O	
Max. suction height (flooded)	5 m H ₂ O	
Max. suction height (dry)	3 m H ₂ O	

Electrical Data

Motor type	Linear magnetic drive	
Nominal voltage	12 V 50 Hz/ 24 V 50 Hz	
Max. power consumption	3,9 W	
Protection class	IP00	

General Data

Ambient temperature	0 to 50°C	
Media temperature	0 to 50°C	
Weight	0,165 kg	

Wetted Parts

Pump chamber	PP
Nozzle plate	PBT
Diaphragm	EPDM
Valve gasket	EPDM

All listed values are average values and related to a Silicone tubing, OD 6,5 mm x ID 4,5 mm, Hardness Shore D 50. Tolerances depend on viscosity of media, temperature, position of pump/tubing. Dry running during self priming only. An oscillator for DC supply can be purchased separately under the article number 90520.

Flow Curves

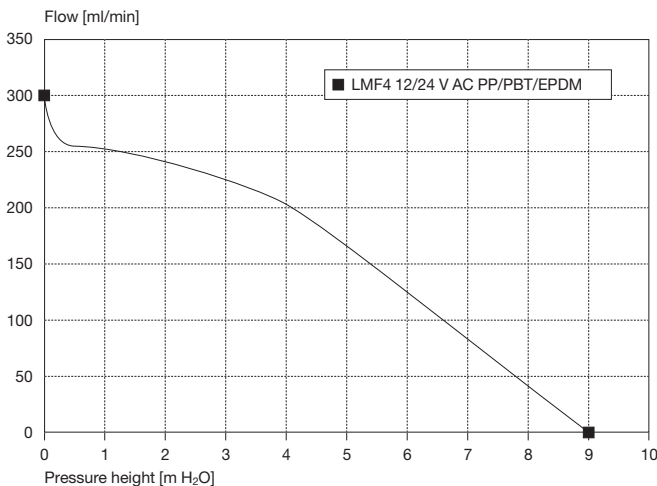

944... Stock programme

The information presented in this material is based on technical data and test results of nominal units. It is believed to be accurate and reliable and is offered as an aid to help in the selection of Thomas products. It is the responsibility of the user to determine the suitability of the product for the intended use and the user assumes all risk and liability whatsoever in connection therewith. Thomas does not warrant, guarantee or assume any obligation or liability in connection with this information.

THOMAS
A Gardner Denver Product



ClimatePartner[®]
climate neutral

Partnership ID: 53097-1301-1001

Printed in Germany.
Art.-Nr.: 17001016 07/2013

Gardner Denver Thomas GmbH
Benzstraße 28 · Gewerbegebiet Nord · 82178 Puchheim · Germany
Phone: +49 89 80900-0 · Fax: +49 89 808368
e-Mail: thomas.de@gardnerdenver.com · <http://www.gd-thomas.com>